



Final conference

WP3 – Track

Anders Ekberg & Samir Assaf

2019-01-22

GA H2020 - 730841



WP3–Enhanced track

Overall objectives

- Research in WP3 aims to significantly improve track structure performance in terms of
 - costs (in a life-cycle sense)
 - robustness (in a RAMS-sense)
 - performance (e.g. load carrying capacity).
- WP3 develops innovative solutions in form of
 - products
 - methods (e.g. system technical evaluation framework)
 - processes (e.g. track status assessment and maintenance execution)
 - procedures (e.g. establishment of technical requirements)

WP3 – Enhanced track Tasks and Deliverables

- Task 3.1 (D3.1): Status, prioritised areas of improvement, and key influencing parameters
- Task 3.2 (D3.2): Enhanced prediction and design of track
- Task 3.3 (D3.3): Enhanced track maintenance and operation

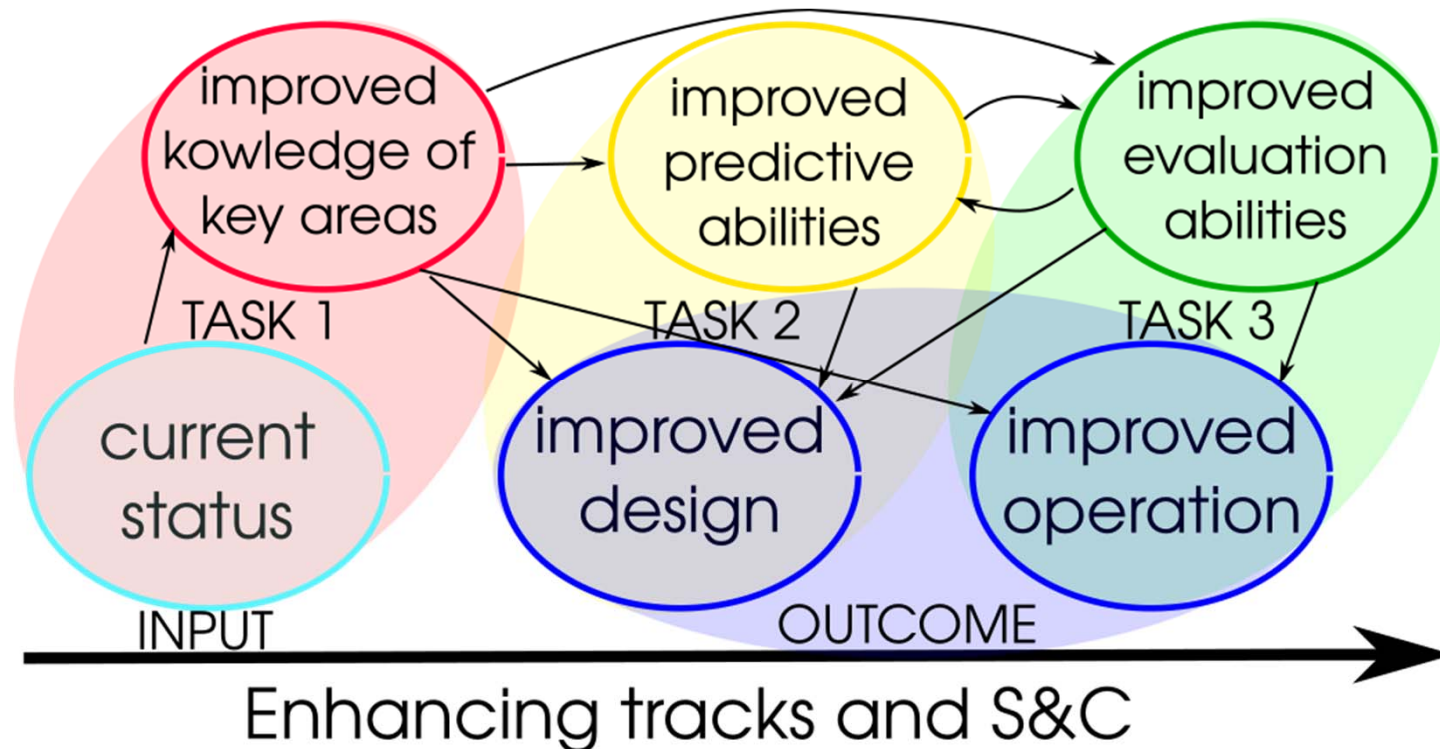



D3.1–Status and improved knowledge in prioritised areas

- 268 pp and 15 annexes
- Main chapters
 - Links between failures and root causes
 - Maintenance technologies based on analyses of failures and costs
 - Optimized track support
 - Optimized mounting, connection and repairing techniques – improving welds by shot peening
 - Key areas for inspection and monitoring
 - Conclusions and input to demonstrators

Failures—causes: Squats

- Extensive overview of initiation and growth
- Influence of surface defects on dynamic loads
- Influence of martensite

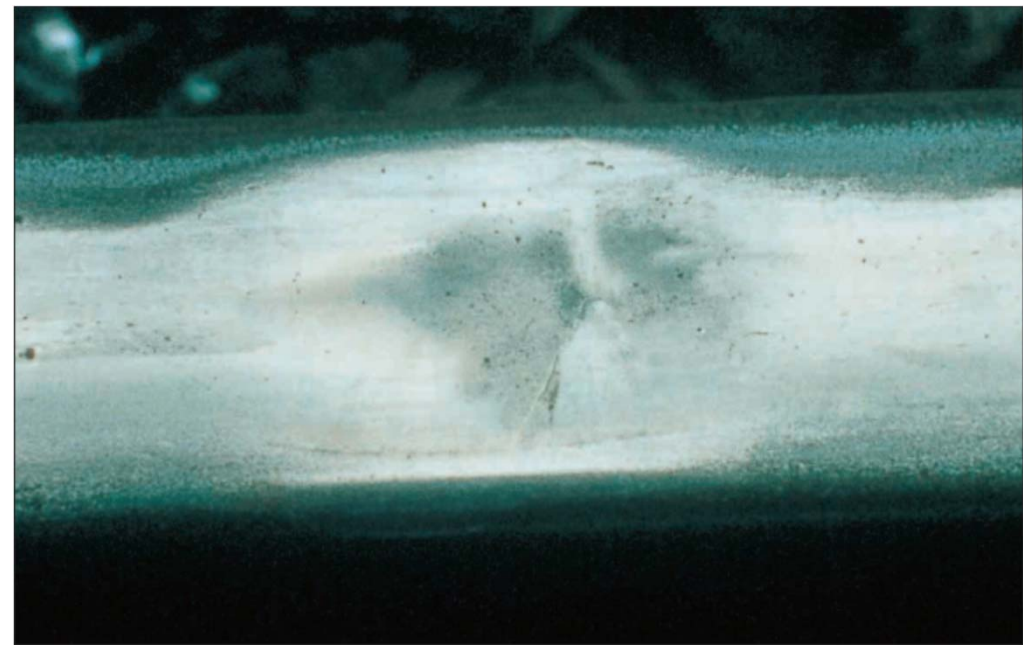
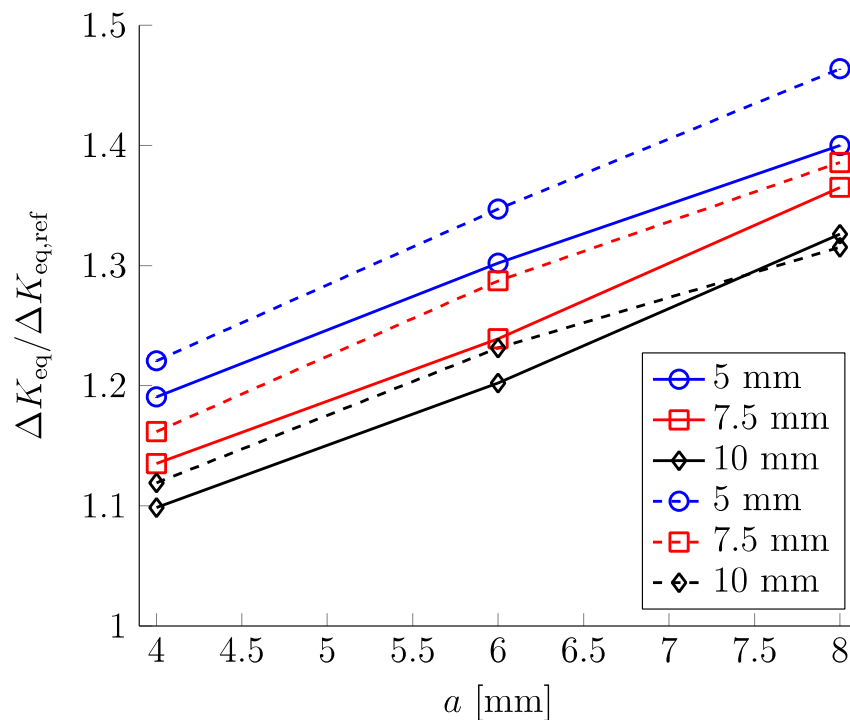
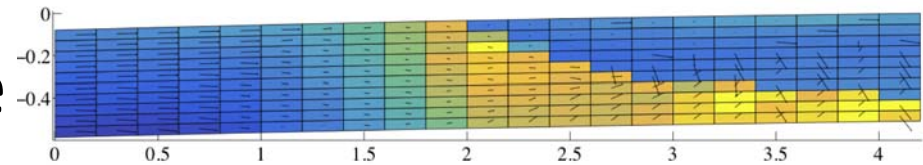

Failures—causes: Cracks

- Evaluation of methods for characterizing sub-surface squat crack networks – methods complimentary
- Testing the effect of surface friction – time variations (run-in) and directional influence
- Testing of the influence of martensite spots on fatigue resistance – initiation in martensite

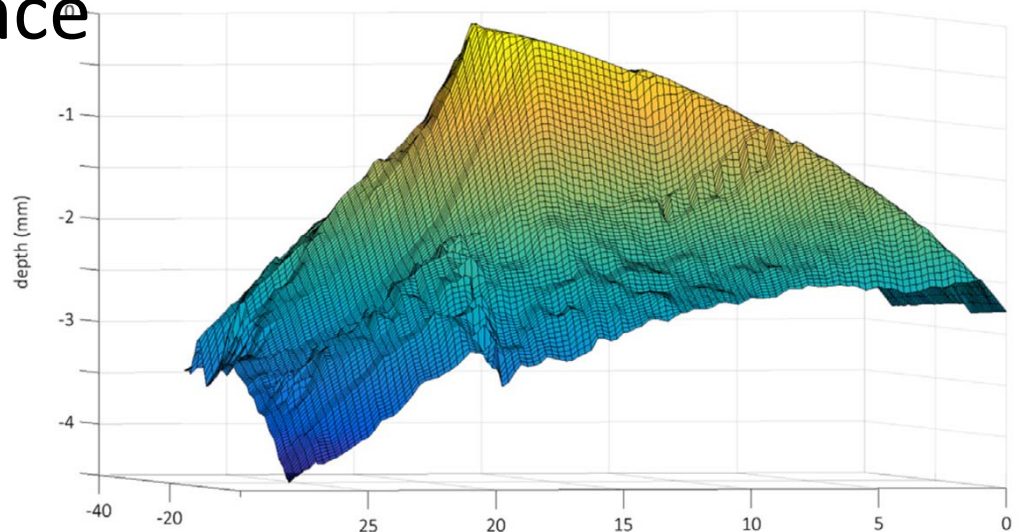

Failures—causes: Anisotropy

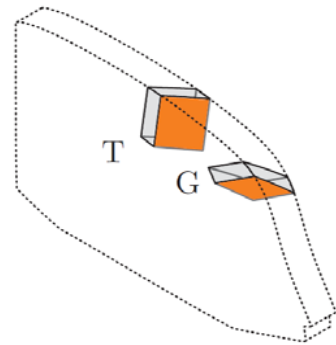

Problem:
Nonhomogeneous strain – thin surface layer

Solution:
cylindric test bars:

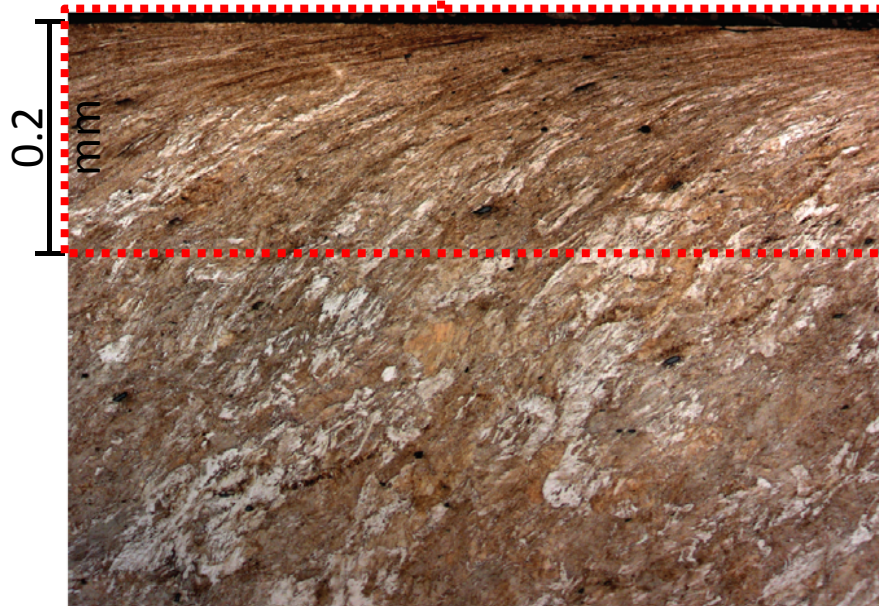
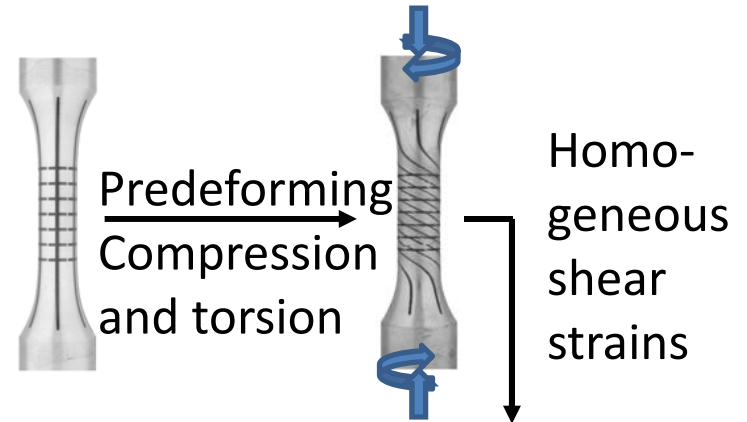

Rail at gauge corner (G)

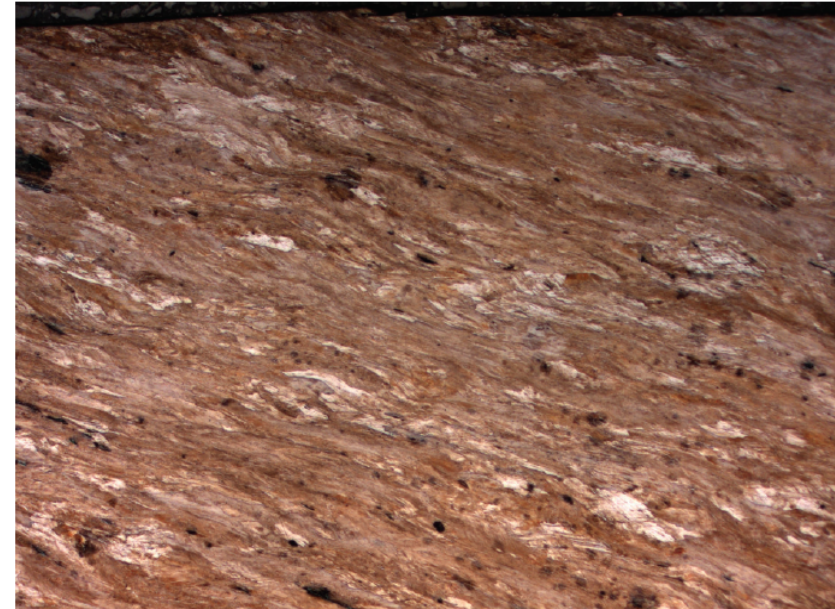

Test bar

Failures—causes: Bainitic steels

- Investigations of bainitic rails in the Eurotunnel and under mixed conditions
- Excellent RCF resistance
- Weak point: heat affected zones are wide – this is further investigated

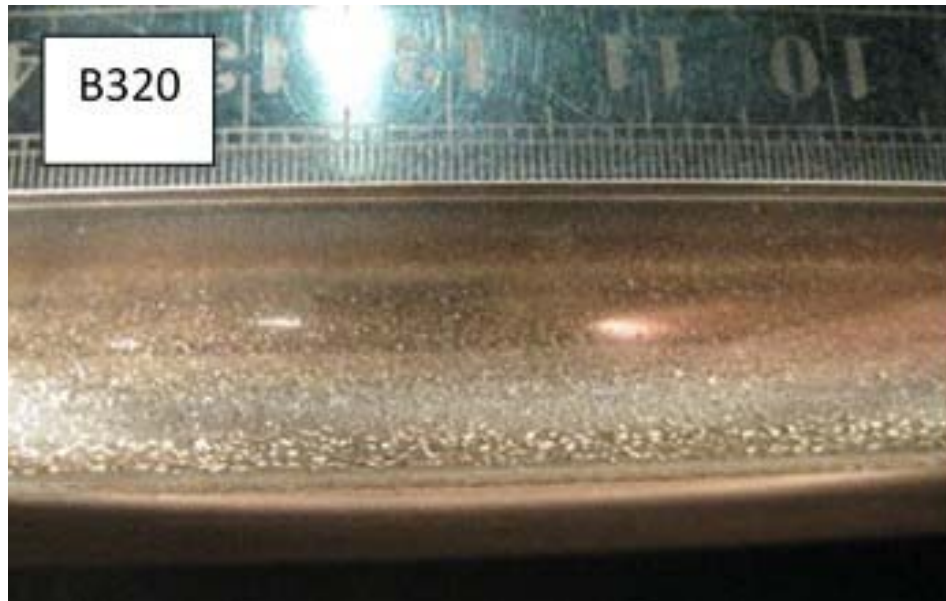

Failures–causes: classification

- Investigation of existing damage catalogues – use UIC and Capacity4Rail
- Operational inspection classification and action for surface cracks – example

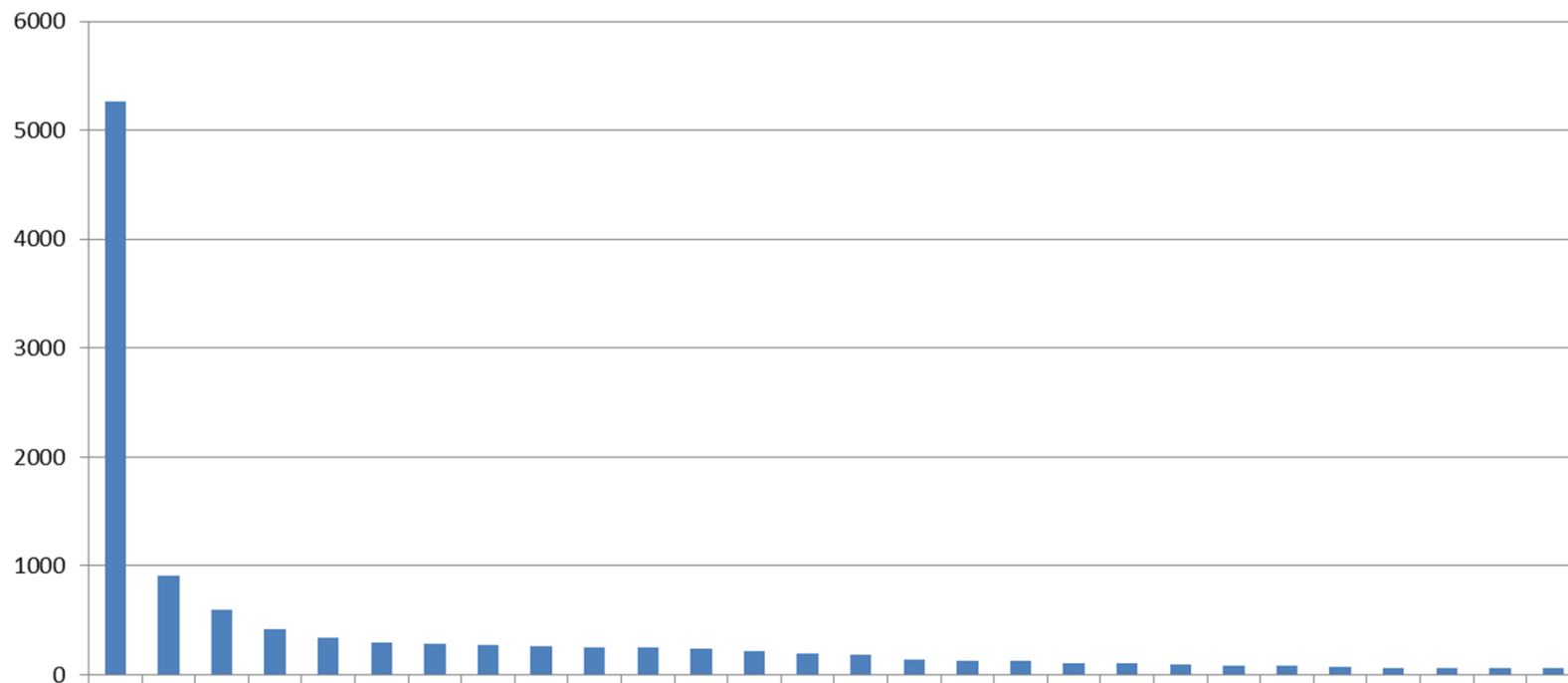

Failures and costs: database

- Description of assets
- Properties, defects, interventions etc...

- Also discussions of proper calculation of cost with operational example

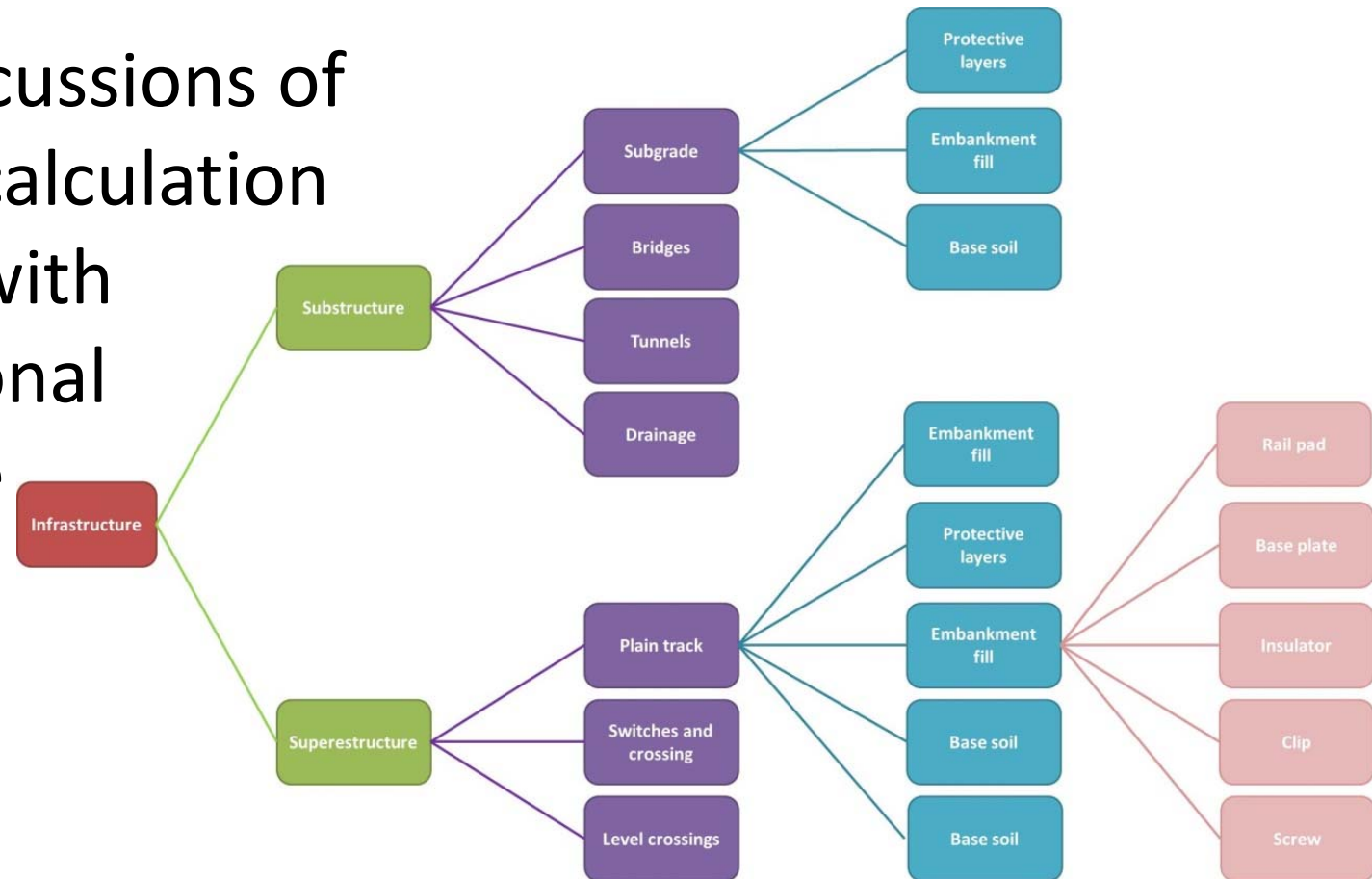

Failures and costs: maintenance requirements

- Investigation of how wear and RCF decreases with rail hardness for pearlitic rail steels
- This causes less need for grinding
- Investigation of grinding induced squat defects

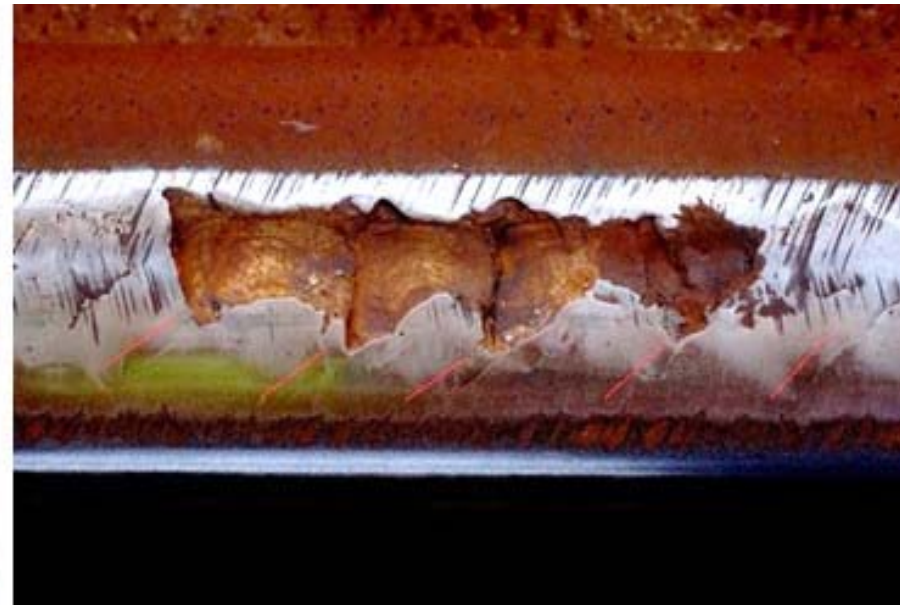

Track support: under sleeper pads (USP)

- Investigation of the influence of USP in a transition zone

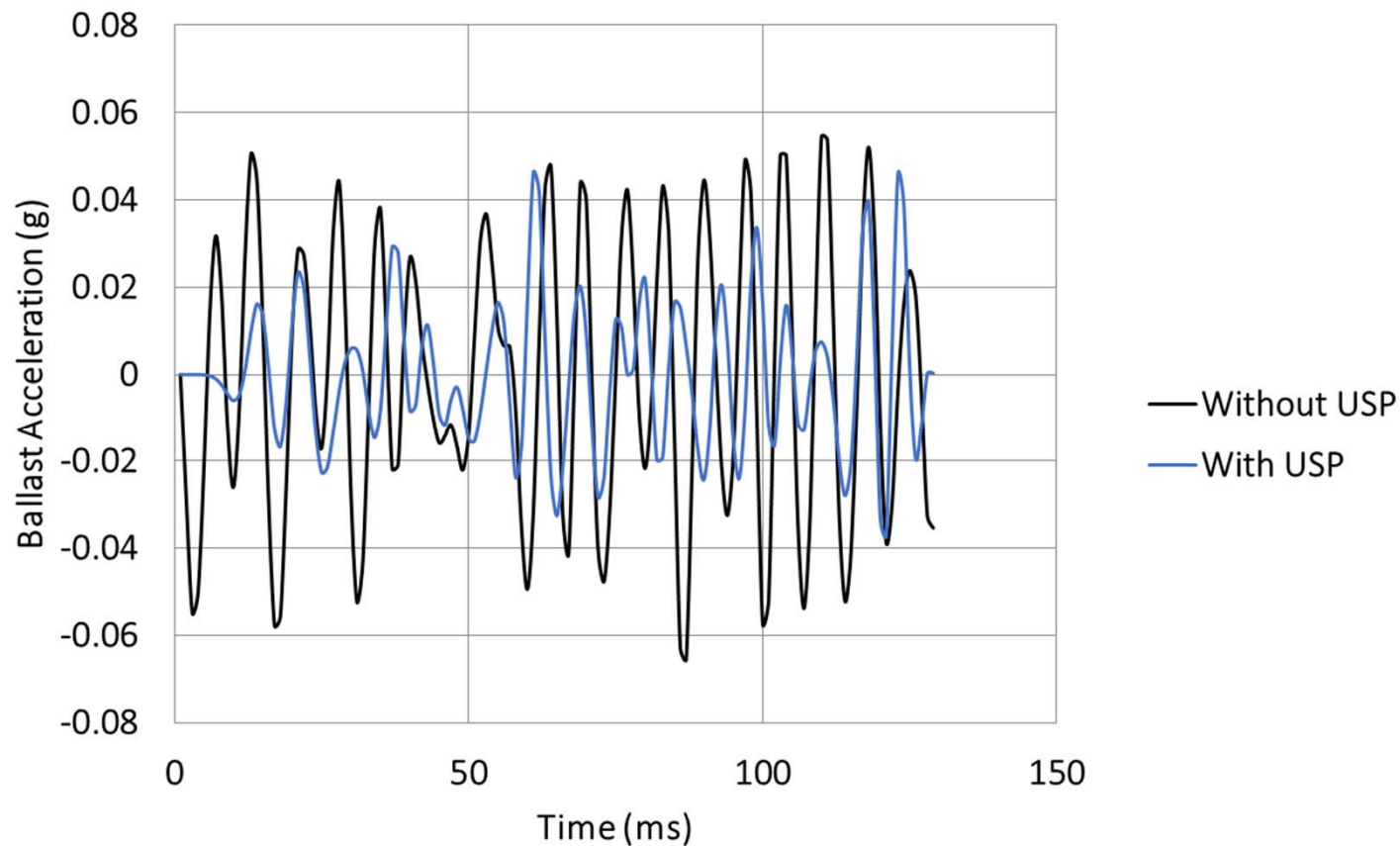

Track support: bituminous sub-ballast layer

- Field and lab tests of different mixtures and e.g. influence of moisture
- Field tests show reduced maintenance needs
- Strain levels are low – standard mixes are OK

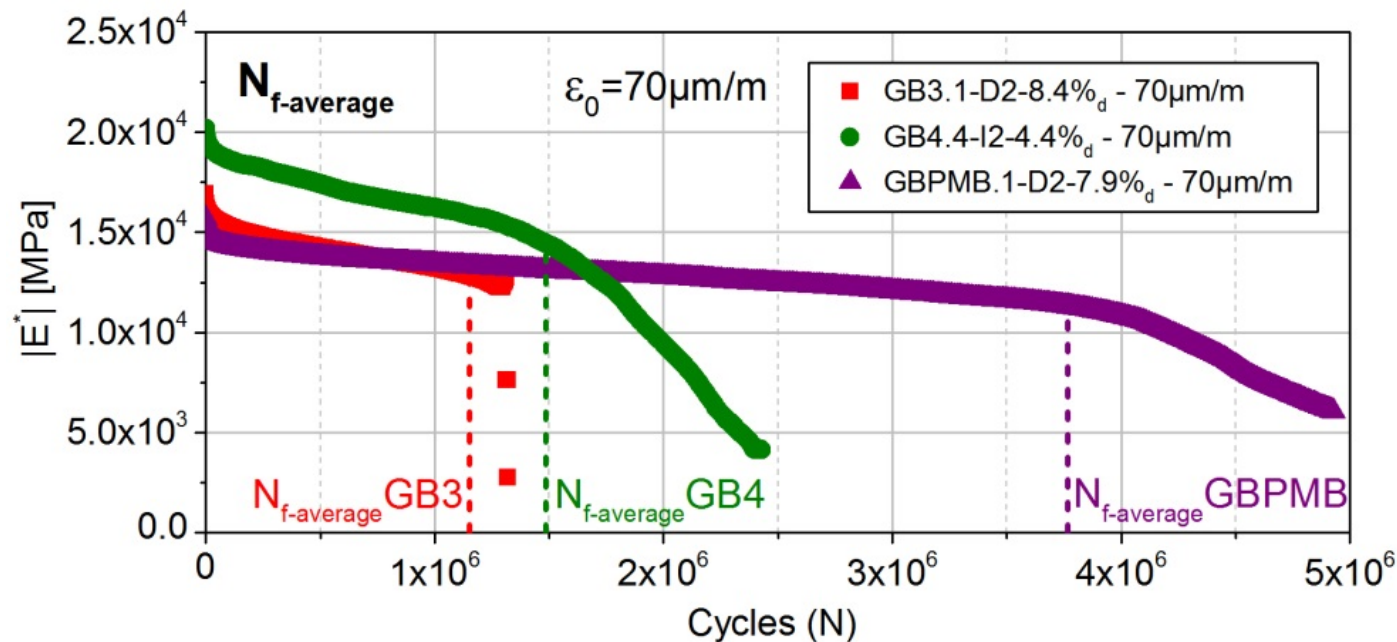

Track support: tests of bituminous sub-ballast layer

- Lab tests of a 340MGT cyclic compression test, a static compression test of the same ballast track and a static compression test with the ballast removed.

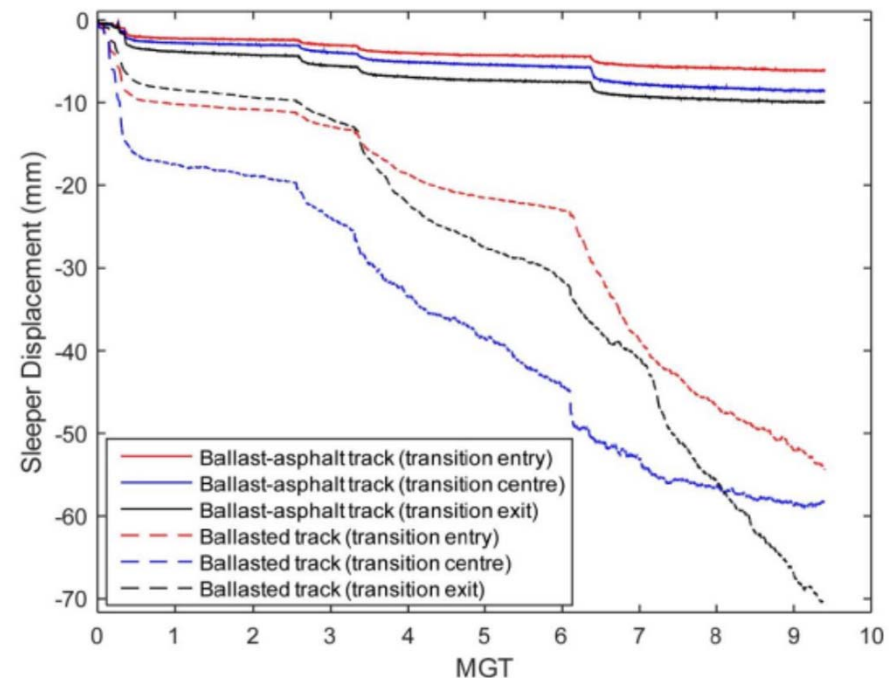

Optimized repairing: shot-peening of welds

- Introduces compressive residual stresses at the weld surface
- Longer life (run-out) in fatigue tests

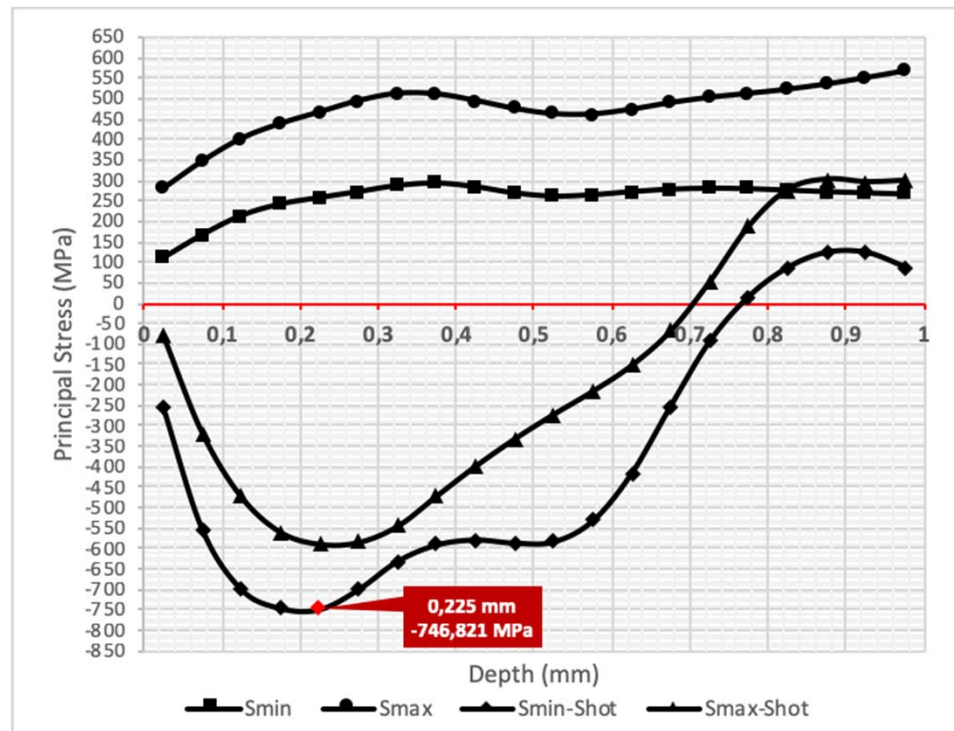



Inspection/monitoring: rail break detection

- Extensive review of current rail break detection inspection and monitoring technologies. Deficiencies and selective properties of the technics are discussed.
- Identification of key areas for track inspection and monitoring and pertinent potential benefits
- Exemplification of practices at NR



D3.2 Enhanced track design solutions through predictive analyses

- 330 pp and 10 annexes
- Main objectives
 1. Improvements of track structures
 2. New alloys and welding methods
 3. Overcoming limitations of existing predictive methods
 4. Improved prediction of rail and track deterioration
 5. Improve design through simulations
 6. Whole system model framework
 7. Quantification of overall track performance

Improvements of track structures (1/3)

- New modular track system



- Based on the concept of multiple-level modularity
 - High degree of prefabrication and assembly process quality
 - Simplification of the construction process
 - Adaptability to changing traffic demands
 - Fast and easy maintainability

- New design of continuously supported precast concrete ballastless slab track

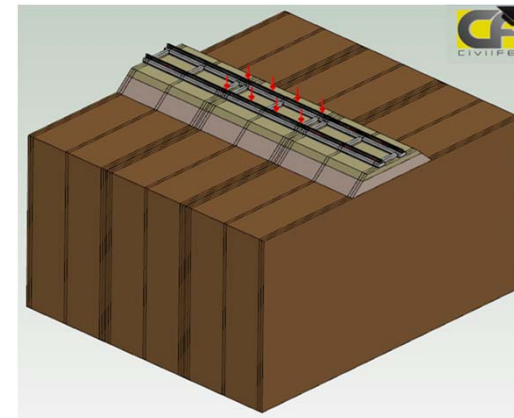
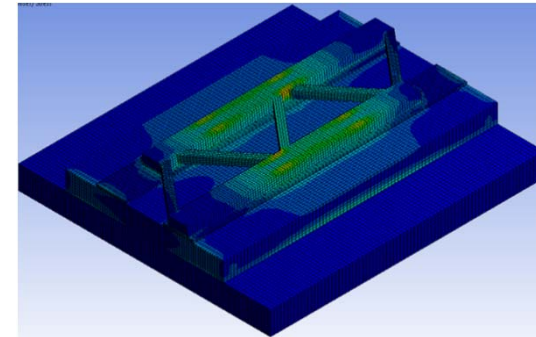
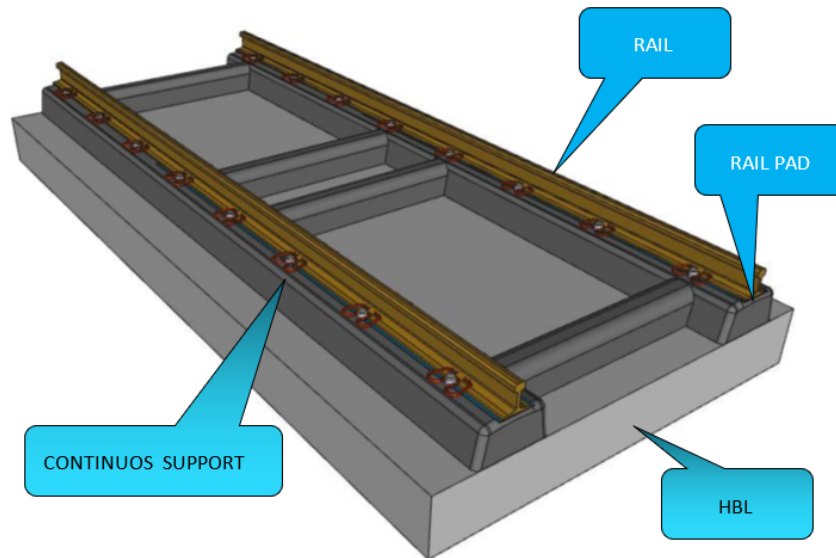

- Modular precast longitudinal beam
 - No pinned-pinned resonance
 - Light weight, fully precast system

Assessment of preliminary designs

Improvements of track structures (3/3)

- Track reinforcement using ballast gluing
 - Geometry monitoring of a ballasted track section (1440m High Speed Line)
 - laboratory lateral resistance measurement of glued ballast

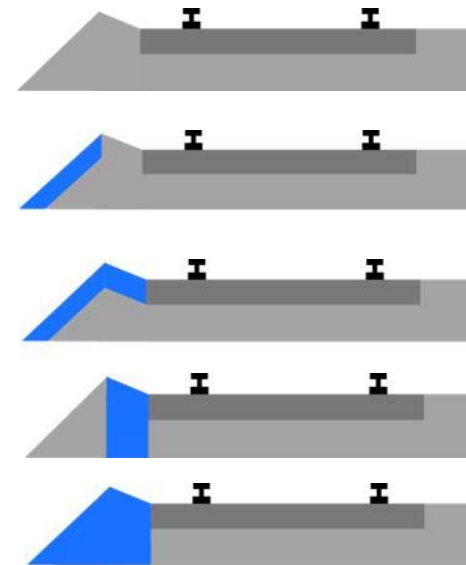

Lateral resistance test configuration Gluing configurations tested

- No impact of surface ballast gluing on the evolution of the track geometry
- Lateral resistance significantly increased (20% - 60%) depending on glue location and depth

New alloys and welding methods

- Modification of the metallurgical structure and hardness of welds in bainitic rails
 - Correlation of the hardness profile with the evolution of the microstructure
 - Explanation of the cupping and cracks found in track on some welds

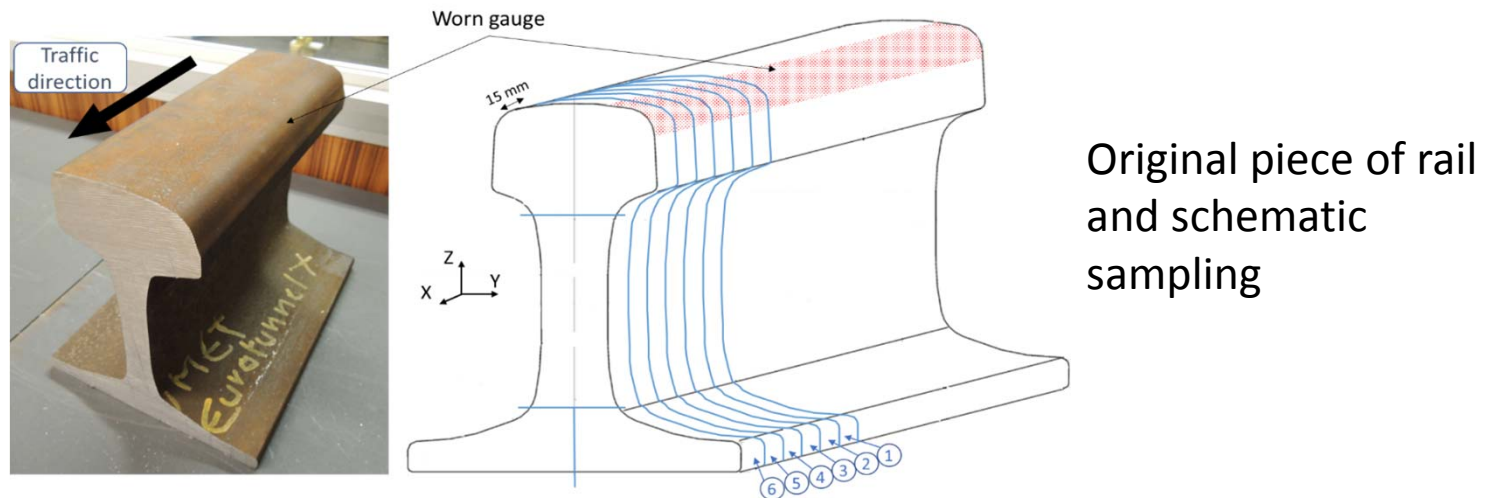

- Mechanisms of the head checks resistance of bainitic rails
 - Identification of key parameters in bainitic steel damage mechanisms
 - Proposition of a scenario linking the bainitic microstructure to the resistance to head checks

Overcoming limitations of existing predictive methods

- In-depth investigation of limitations in prediction of rail crack formation, wear and rolling contact fatigue
- Improved predictive tools for rail and track deterioration
 - New approach to assess the Stress Intensity Factor (SIF) of loading cracks
 - Influence of thermal loading
 - Welding effects
 - White Etching Layers (WELs) formation and squat
 - Influence of repeated local heating events
 - Predictive model of the anisotropic behaviour of rail steel
 - Improved simulation of rail crack formation

Improve design through simulations

- Improved predictive tool for modelling the whole ballasted track
 - New approach coupling continuous and discrete representation of the ballast layer
 - Calibration of the new model



Global displacement magnitude in a pass-by train simulation

- Current work on reducing the computational cost

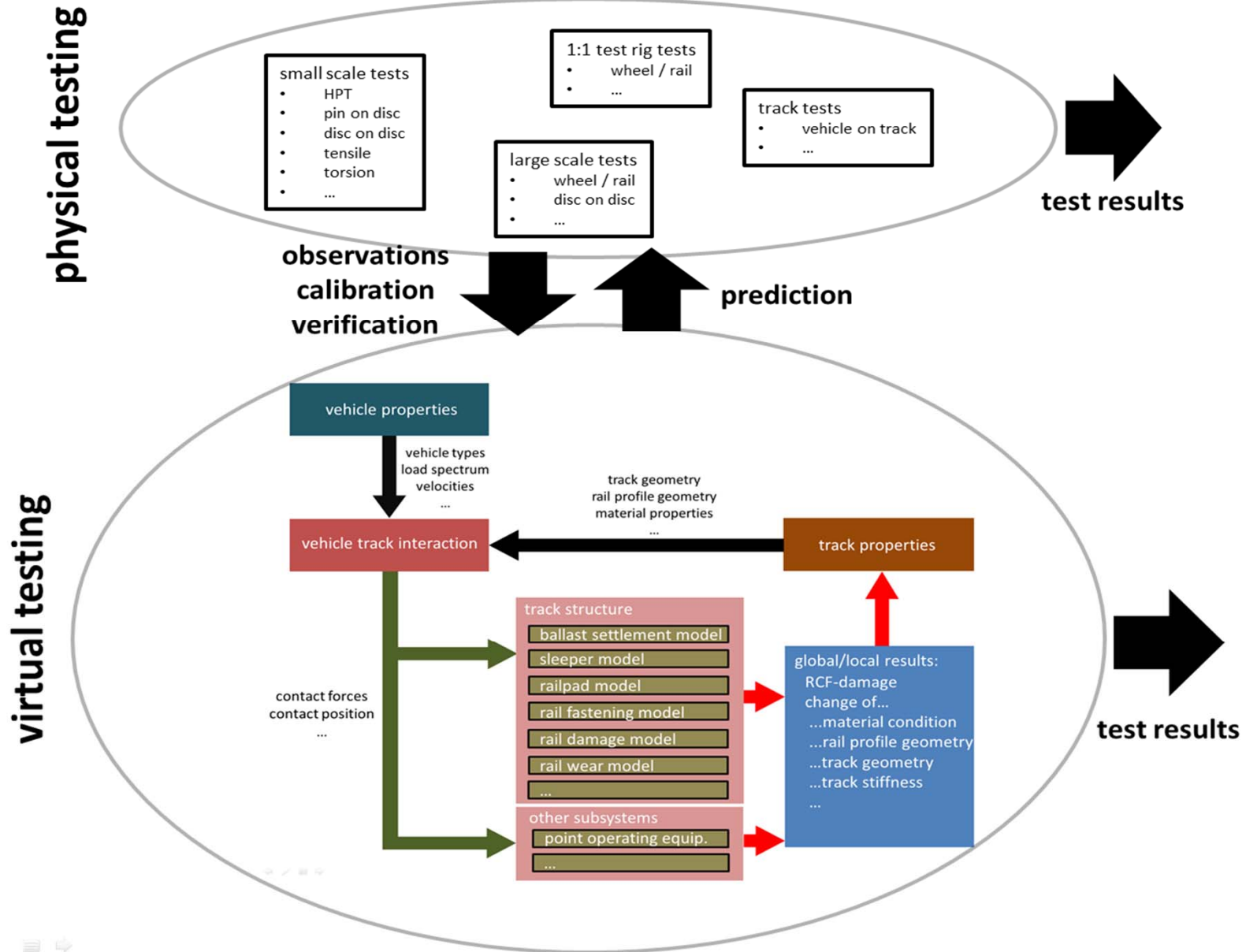

Whole system model framework (2/3)

- Combine models at different levels of detail and complexity for holistic analysis of rail crack initiation and growth
- Subsystem to model squat
 - Combines several models for normal contact problem, tangential contact problem, wear problem and crack initiation potential

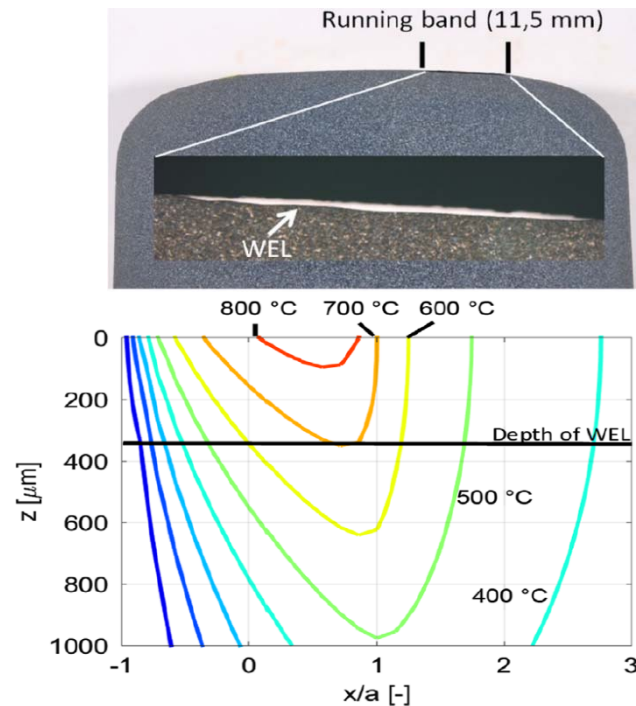

Experimental validation - Simulated temperature distribution

- Optimisation of Track Stiffness
 - Optimum global track stiffness by minimizing the strain energy for the entire train-track system

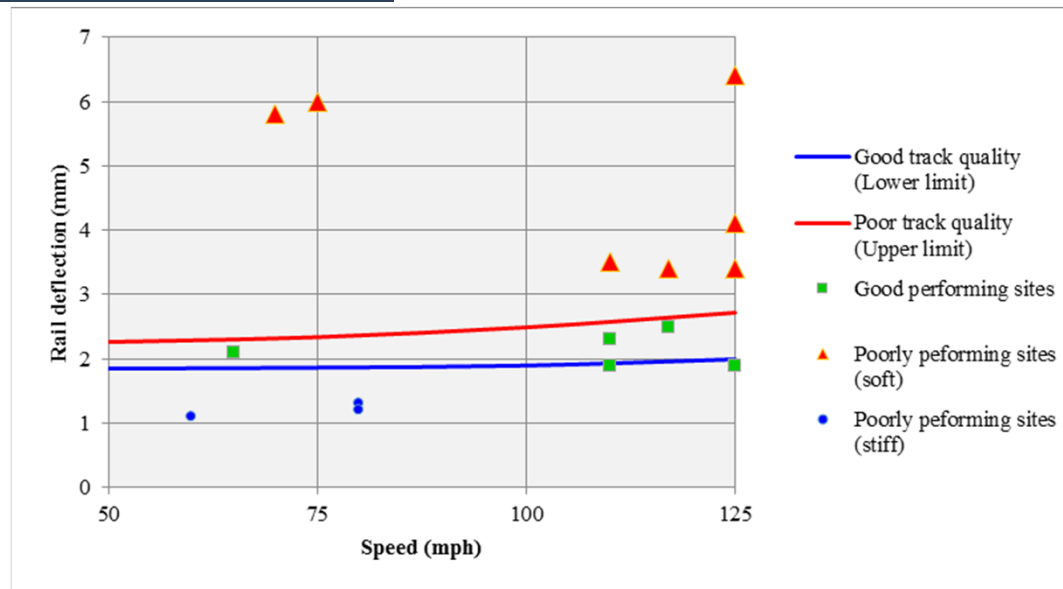
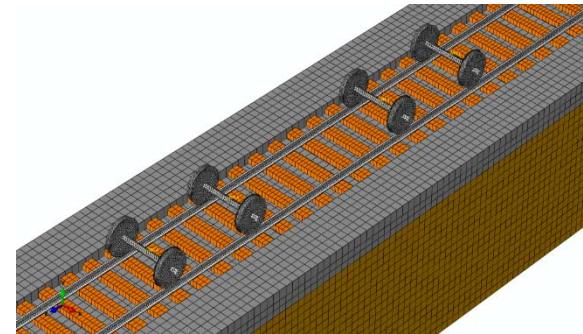
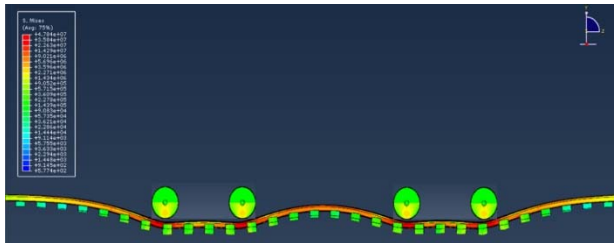

Rail deflection based on optimum global stiffness value for a passenger train

Quantification of overall track performance (1/2)

- Overall track performance quantification of grooved rail tracks

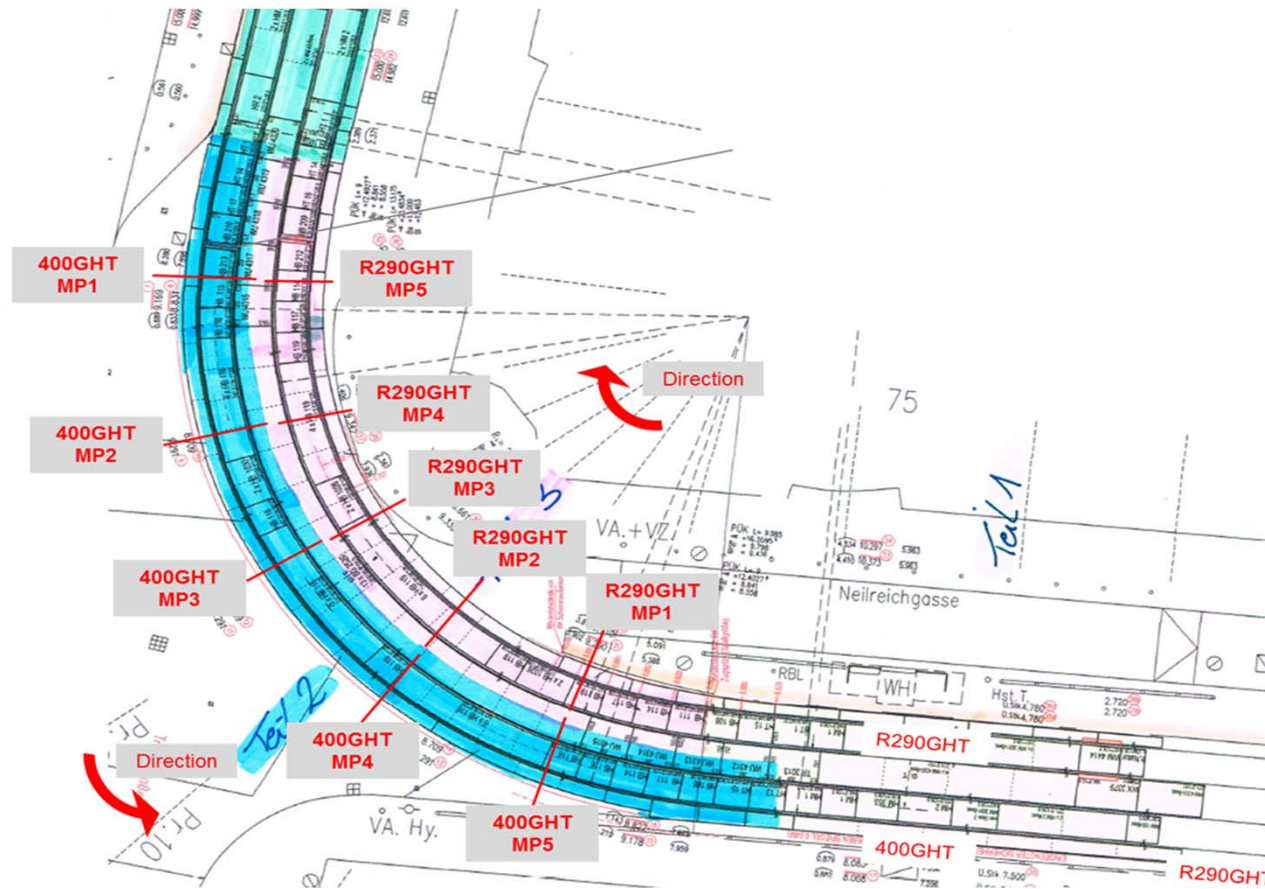

Grooved rail test track at Wiener Linien indicating the rail steel grades and the measurement spots.

Quantification of overall track performance (2/2)

- Track test results after 2 years of traffic (approx. 10 Mt)
 - Wear profiles, longitudinal profiles of the rails and along the welds

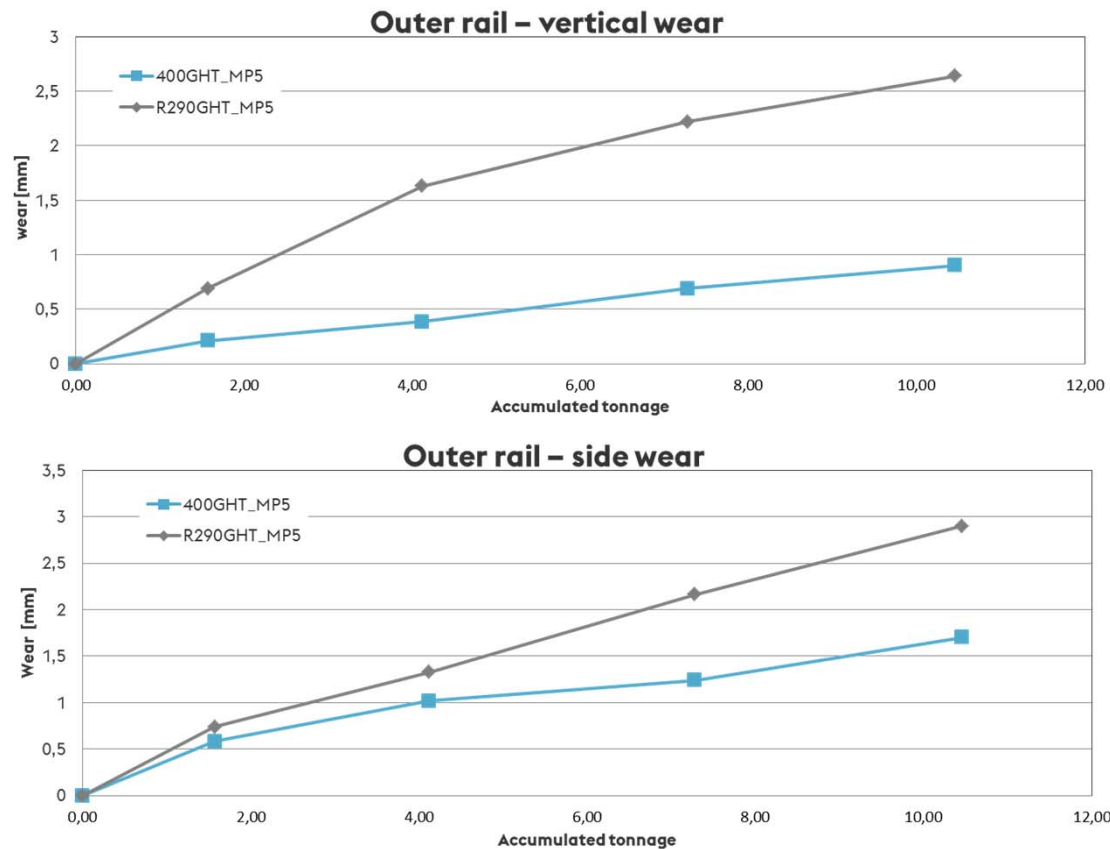

Vertical wear and gauge wear at the same point



D3.3–Enhanced track maintenance and operation

- Around 100 pp (in review) and 7 annexes
- Main chapters
 - Optimal maintenance actions in key areas
 - Rapid maintenance methods
 - Efficient health monitoring strategies and techniques
 - Conclusions and input to demonstrators

Maintenance actions: grinding

- Overview of various types of rail grinding and factors affecting grinding including grinding interval.
- Overview of grinding practices in different countries/regions including practices at TCDD

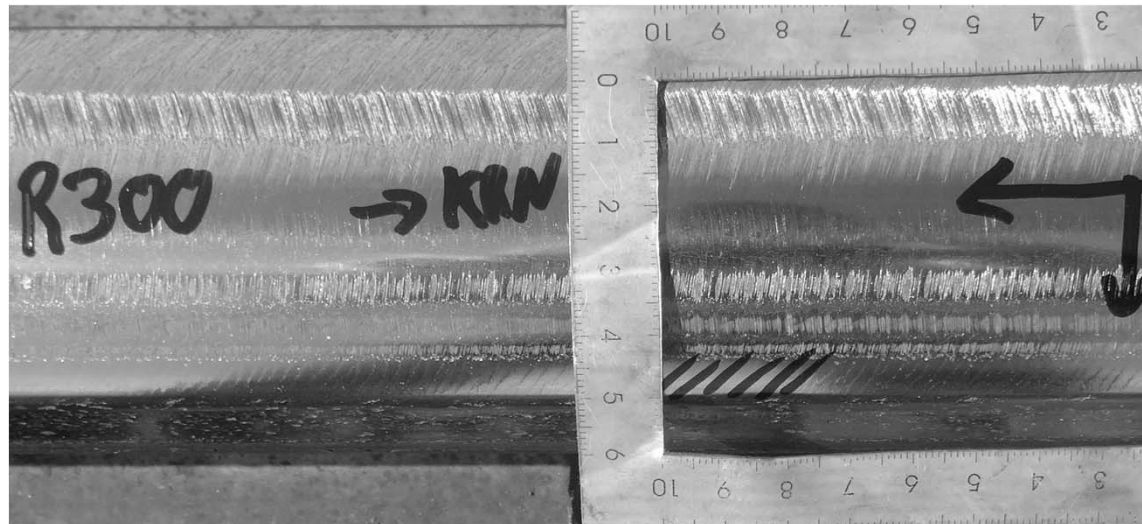

Picture: A Ekberg

Maintenance actions: root causes – anisotropy

- Testing and simulation of formation of anisotropy of pre-deformed specimens
- Most of changes occur after a relatively small amount of pre-deformation
- Therefore not only the rail surface layer, but also deformed material deeper in the rail is anisotropic

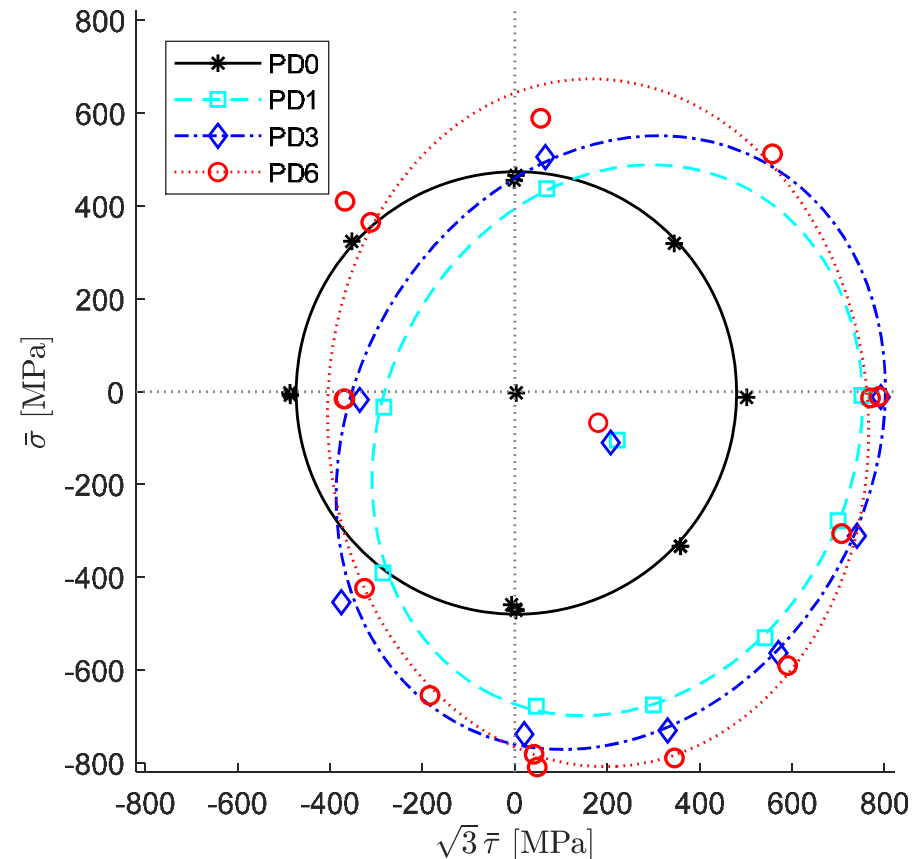

Maintenance actions: root causes – crack growth

- Rolling contact = multiaxial and compressive loading → growth direction not known
- Extensive overview of the topic and means to address

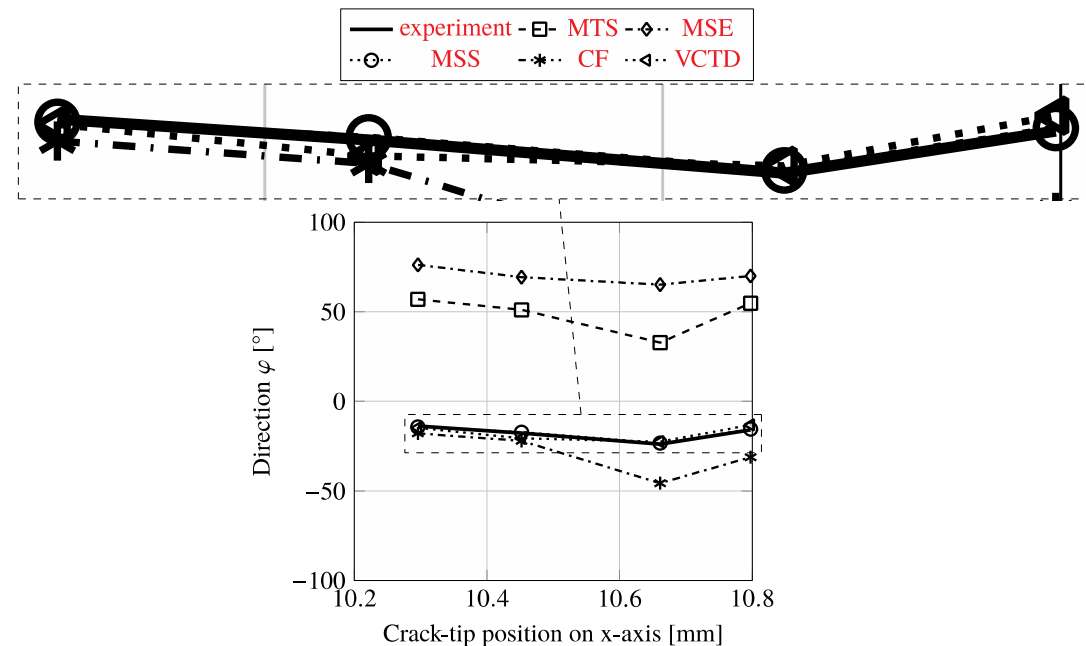
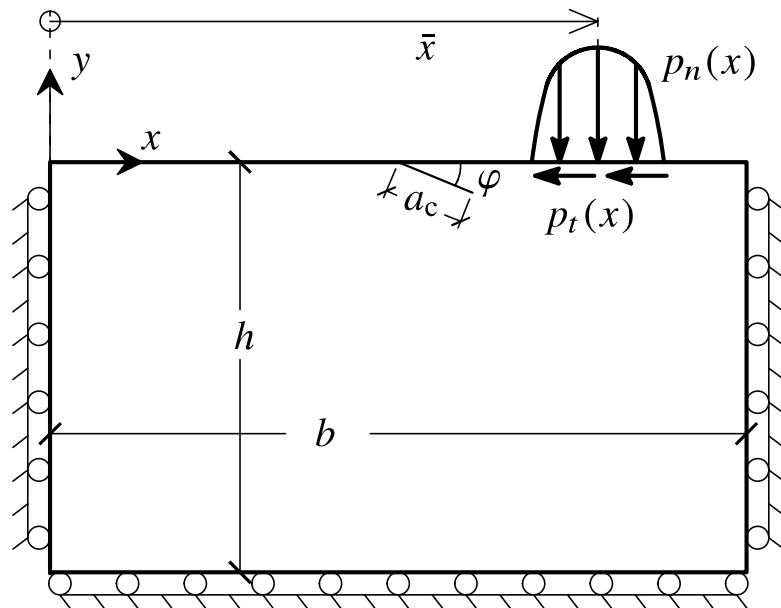

Maintenance actions: repair welding

- Welding results in high t
- Rolling contact reduces t
- Evaluation of risk of subsurface cracks

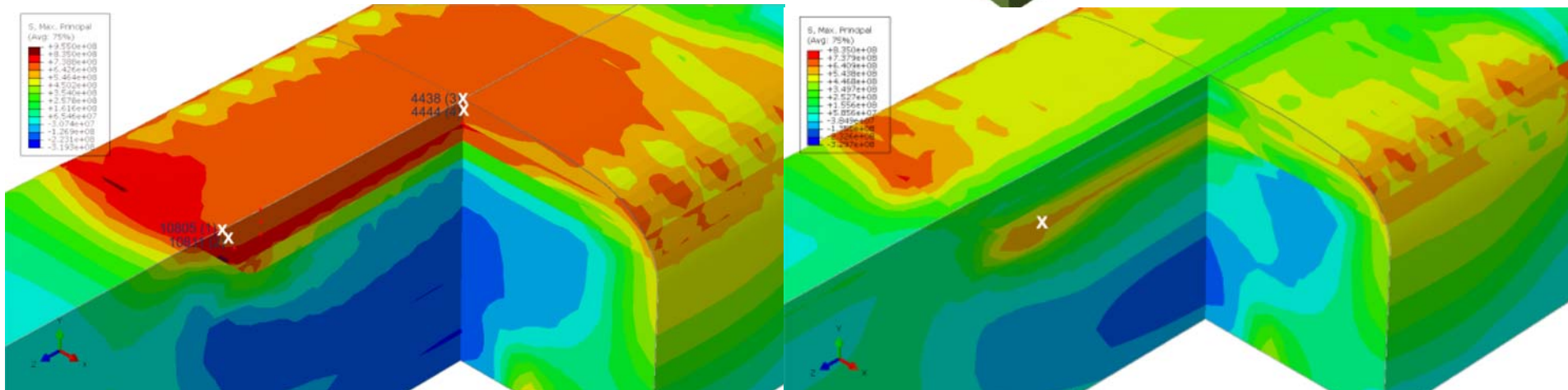
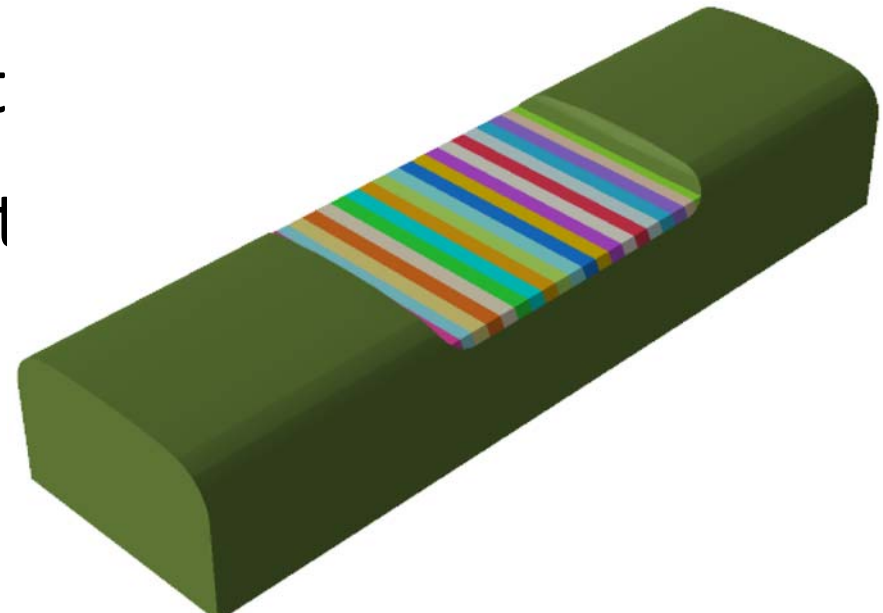

Maintenance actions: urban railways

- Market study of track design, maintenance, noise & vibration

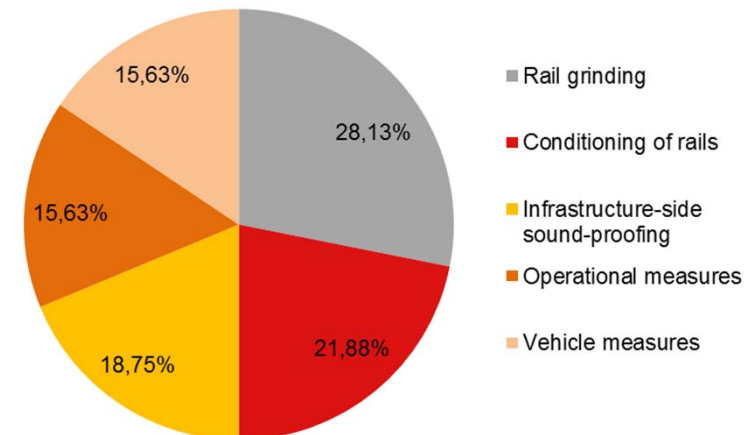
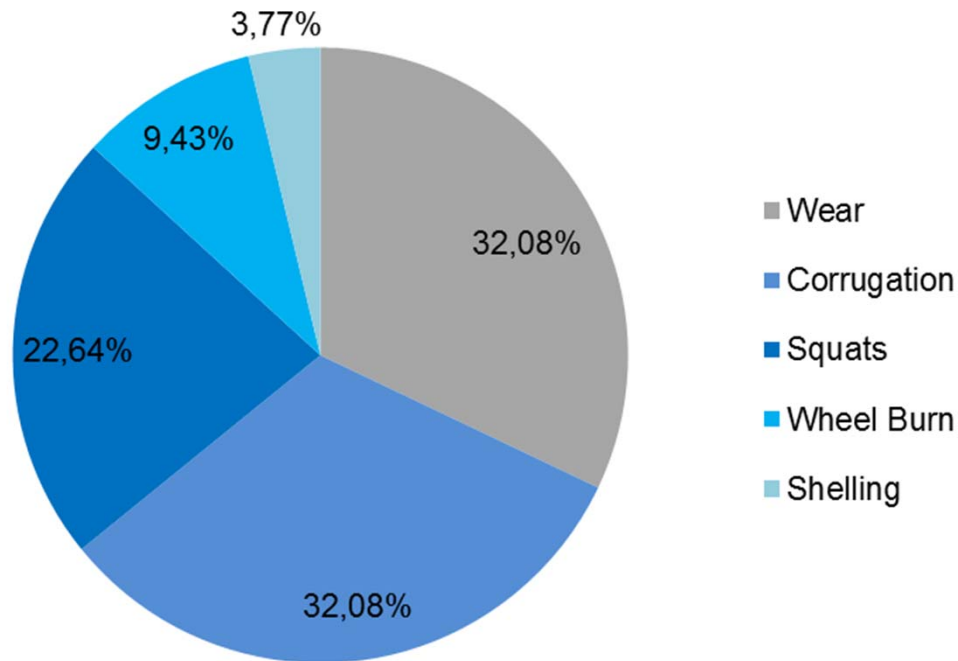

Maintenance planning: asset management strategy

- Use of Plain Line Pattern Recognition (PLPR) to identify rail defects

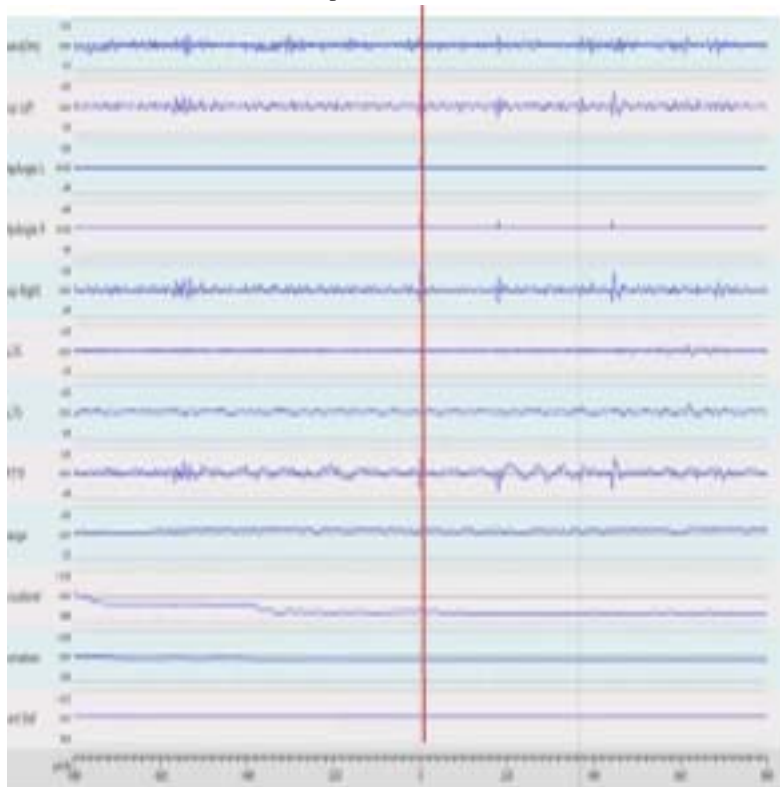

track geometry

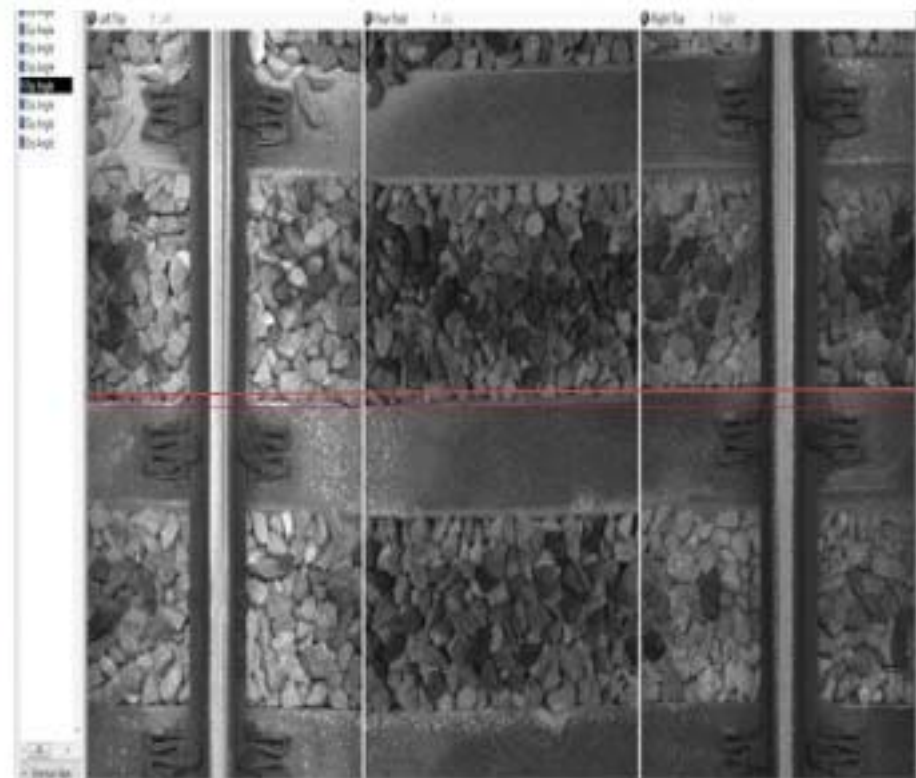

PLPR image

Rapid maintenance: slab track system

- Maintaining modular track systems
- Fibres to reinforce and break

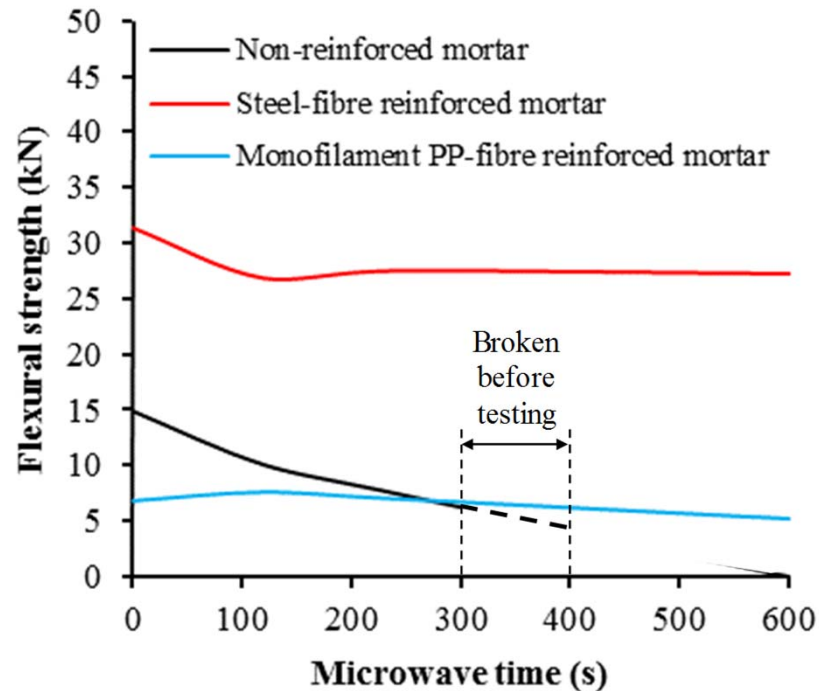
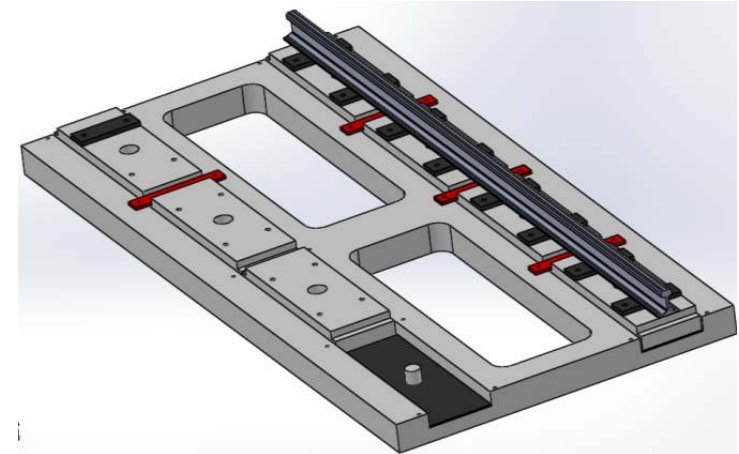

Health monitoring: tonnage sensor

- Monitoring strategy outlined in Capacity4Rail

- placement

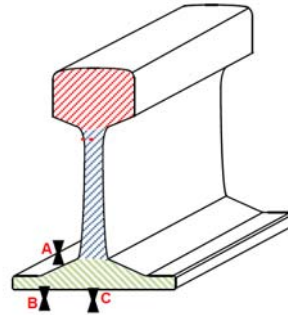

- laboratory and in-track testing

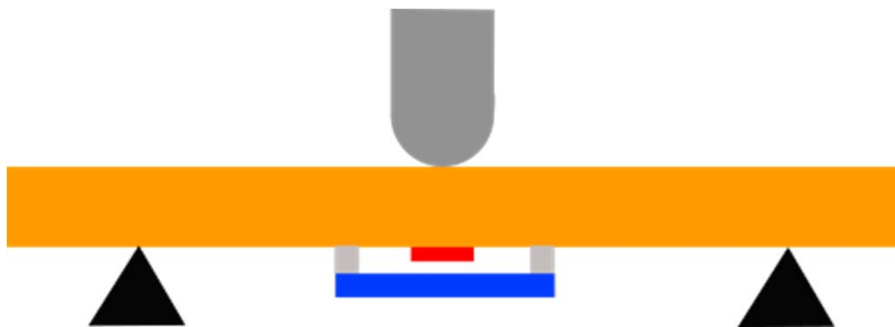
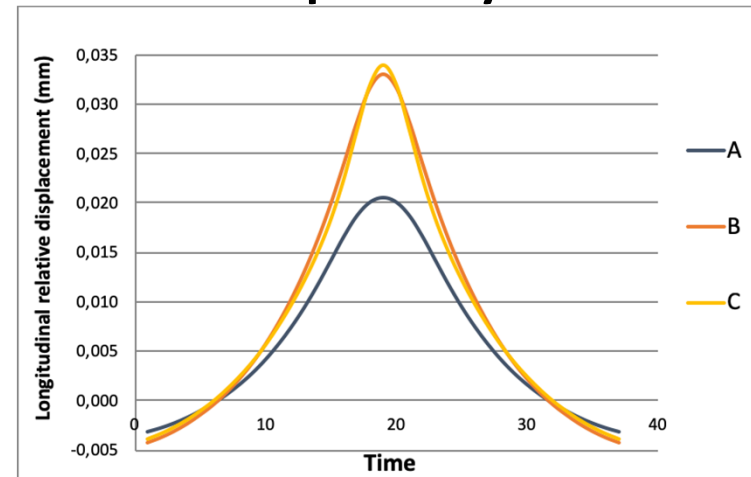

Health monitoring: rail grinding in urban track

- Focus on corrugation
- Parametric study of different grinding strategies
- Can evaluate efficiency of different methods

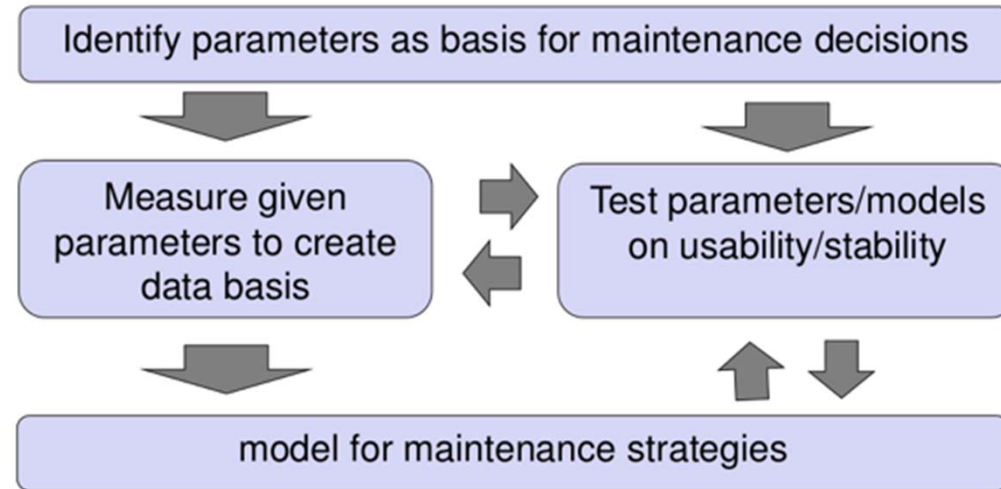

degradation depending on curvature and load

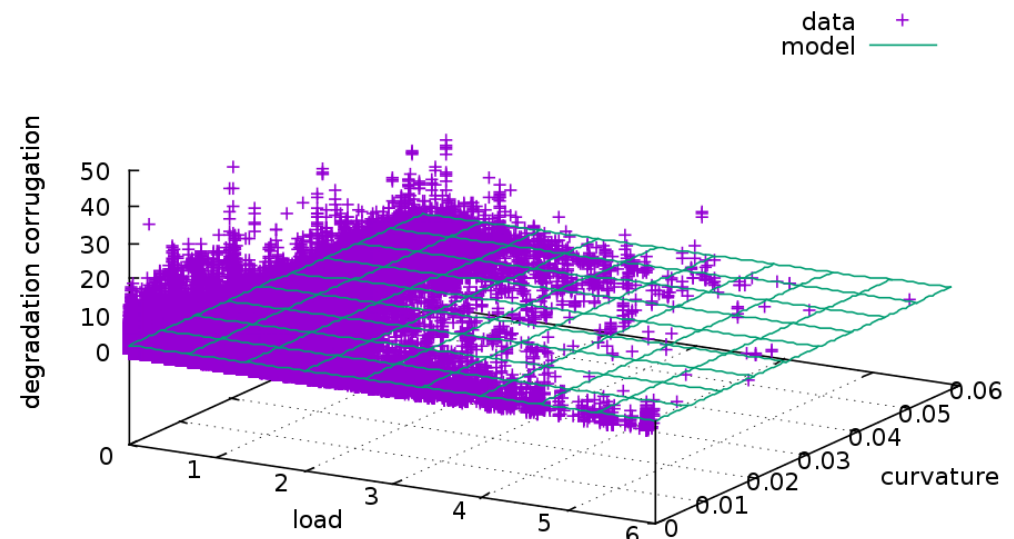

(A lot) more info ...

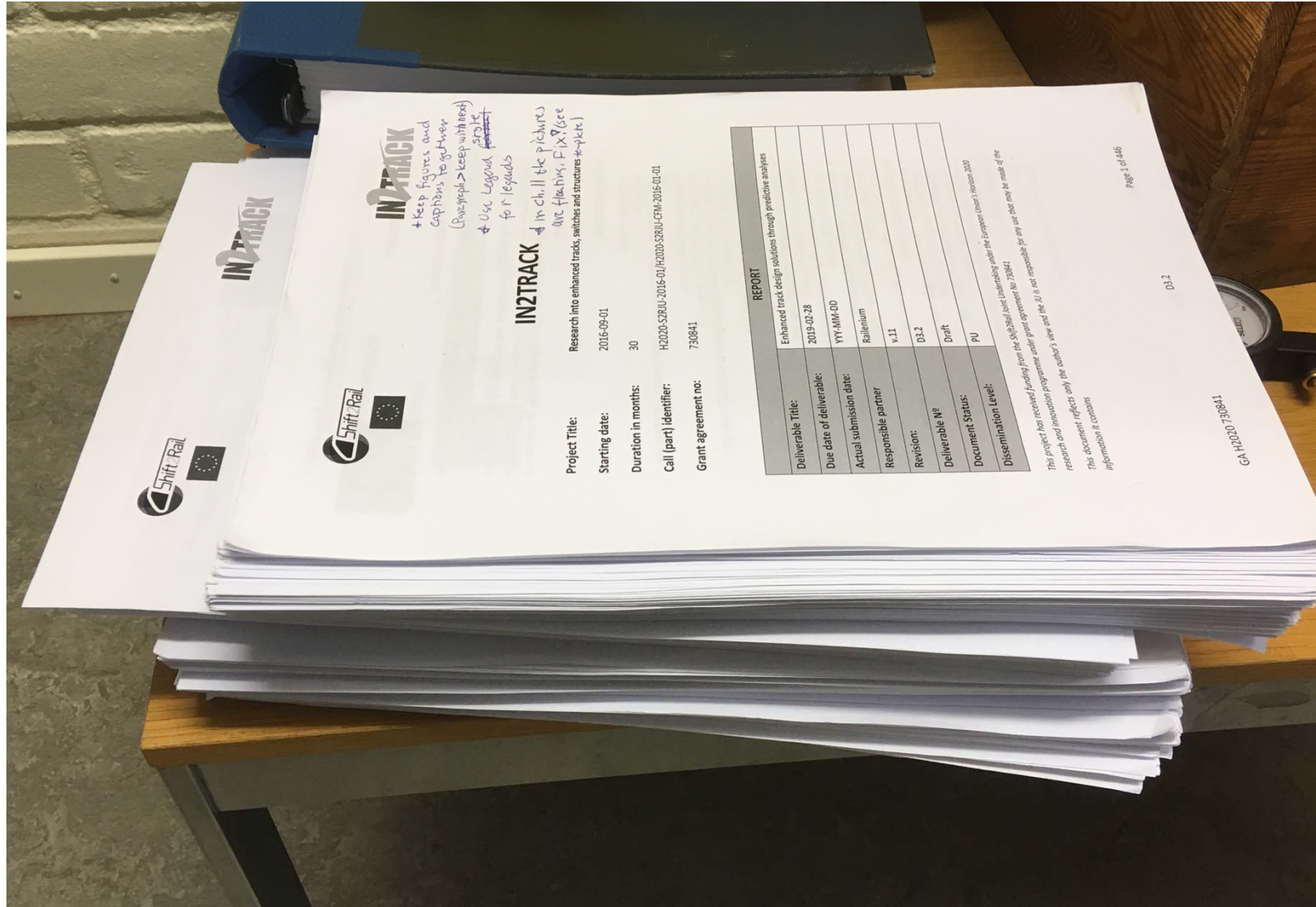

D2.2, D3.1, D3.2 and D4.1 with review comments



Many thanks for your kind attention!